

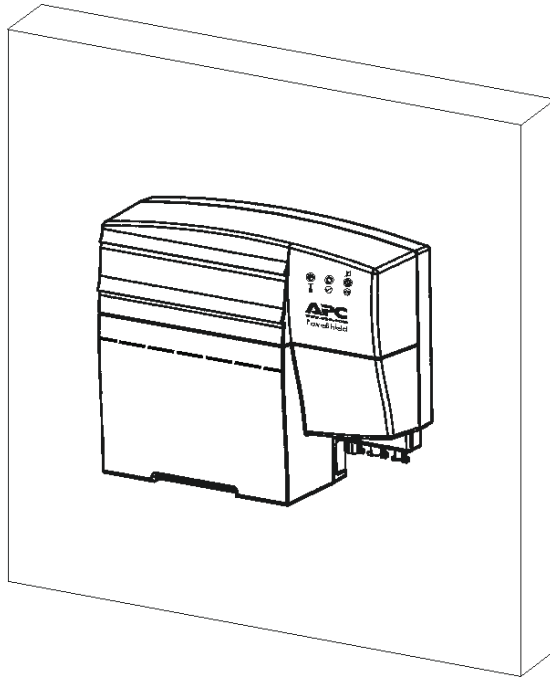

# Broadband PowerShield®

Models: CP16 and CP27

## User Manual





# Chapter 1: General Information

The PowerShield® provides a power source for broadband telephony, Fiber-to-the-Home/Premise (FTTH/P), and other direct current (DC) equipment/applications.

## Safety

This manual contains important instructions that should be followed during installation and maintenance of the APC equipment and batteries. It is intended for APC customers that set up, install, relocate, or maintain APC equipment.

**Changes and modifications to this unit not expressly approved by APC could void the warranty. Failure to observe this warning may result in serious injury, death, or damage to the equipment.**

## Electrical Warnings

Do not work alone under hazardous conditions.

Servicing the PowerShield may require the removal of protective covers, as well as connected utility power. Use extreme caution during these procedures.

Check that the power cord(s), plug(s), and sockets are in good condition.

Replacement of fuses or other parts must be with identical types and ratings. Substitution of nonidentical parts may cause safety and fire hazards.

## Battery Warning

Danger of explosion if the battery is incorrectly connected or replaced. Use only APC replacement batteries.

## Unpacking

Inspect the unit upon receipt. Notify the shipping carrier or product supplier if there is damage.

The packaging is recyclable; save it for reuse or dispose of it properly.

Check the package contents. The package contains the enclosure, the battery (to be installed), one power cord, and the product documentation.

## Specifications

### General

Model Number	Input	Output	Maximum Signal Voltage	Maximum Signal Current	Battery Type
CP16U48	100-240 V 50/60 Hz 1.0 A	48 V 16 W	30 V	5 mA	12 V 7.2 AHr Spill-Proof, Maintenance-Free, Sealed Lead Acid
CP27U13	100-240 V 50/60 Hz 1.0 A	13 V 27 W	30 V	5 mA	

### Environmental

<b>Operating Temperature</b>	-4° F to 122° F (-20° C to 50° C)
<b>Operating Humidity</b>	5 to 95% noncondensing within enclosure
<b>Maximum Operating Elevation</b>	10,000 ft (3,000 m)
<b>Maximum Storage Elevation</b>	50,000 ft (15,000 m)
<b>Storage Temperature</b>	-4° F to 122° F (-20° C to 50° C) *Battery lifetime is reduced with prolonged storage in high temperature (>25° C).

### Physical

<b>Height x Width x Depth</b>	
PowerShield	7.5 x 9.5 x 3 in (19 x 24 x 7.6 cm)
PowerShield carton	13.5 x 13.5 x 4.5 in (34 x 34 x 11 cm)
<b>Weight</b>	
PowerShield	7.15 lbs (3.25 kg)
PowerShield with package materials	9 lbs (4 kg)

# Chapter 2: Installation

## Enclosure Installation

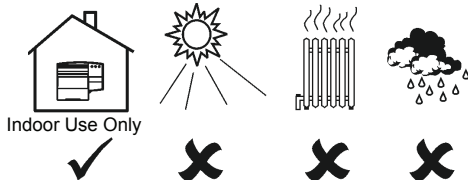

Install the enclosure in a protected area that is free of excessive dust and has adequate airflow.

Do not operate the PowerShield where the temperature and humidity are outside the specified limits. See *Specifications*.

1

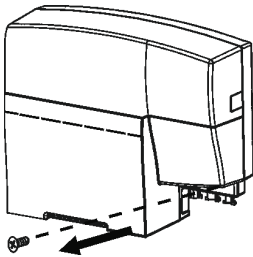

2

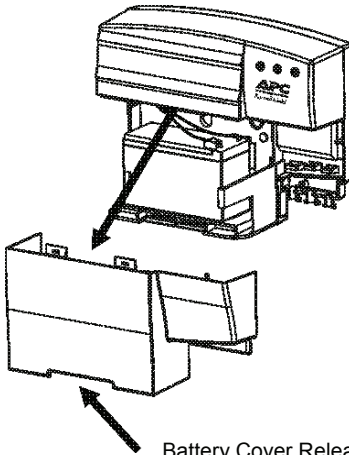

3

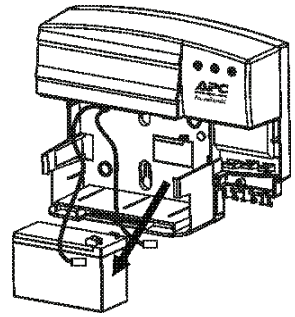

4

Use screws that are appropriate for the weight of this unit and the mounting surface material. See *Specifications*.

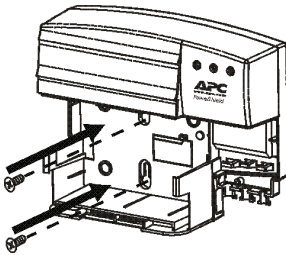

# Battery Installation

1

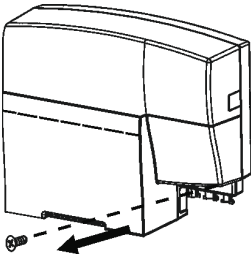

2

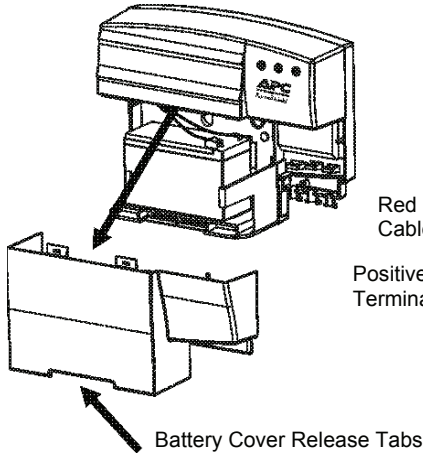

3

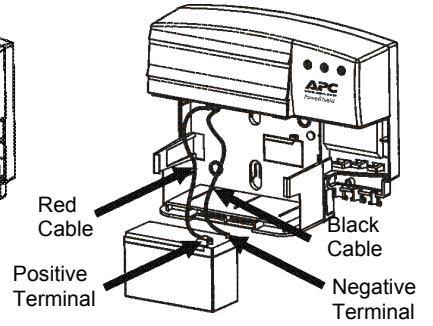

4

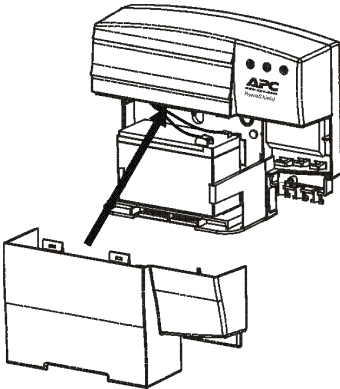

5

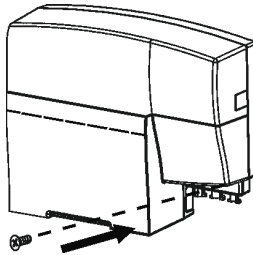

## Connect Equipment and Power



The PowerShield battery charges when it is connected to utility power. The battery charges fully during the first eight hours of normal operation. **Do not** expect full battery run capability during this initial charge period.

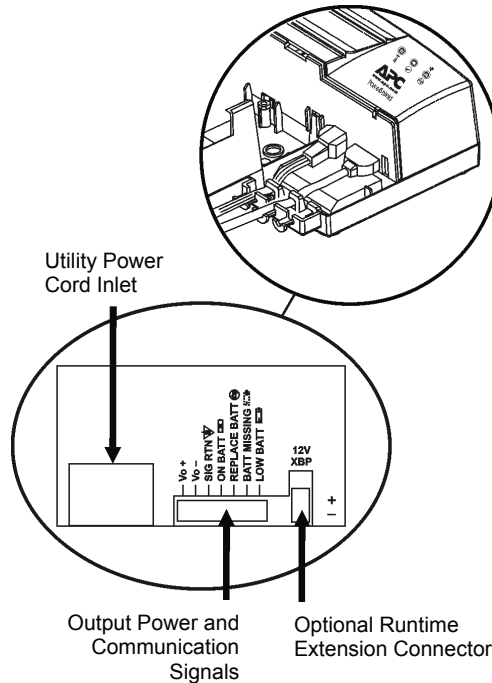

1. Connect the PowerShield to the application equipment (example: FTTH/P Optical Network Terminal) via the seven-pin output connector, using the appropriate cable (must be ordered separately). See [www.apc.com](http://www.apc.com) for a list of available output cables.
2. Plug the PowerShield power cord into the utility power cord inlet and then into the wall outlet.

**Do not overload the wall outlet or circuit.**

Cold Start Feature: Upon installation of a charged battery, power will immediately be applied to the unit even when utility power is not present.

**Attention: To disconnect from utility power, remove the plug from the wall outlet.**

### Optional Runtime Extension



The runtime may be extended by adding the external battery CP20B12BP.

# Chapter 3: Operation

## Status Indicators and Features

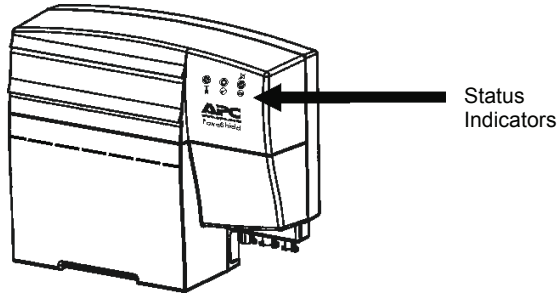
### Front Panel



Indicator	Description
	Solid green indicates the unit is on utility power. Solid yellow indicates that utility power is not present and the unit is on battery power. Flashing green LED indicates the unit is fast-charging.
	Green indicates the unit is working properly and DC output power is provided by the battery or the utility power.
Replace Battery/ Alarm Silence 	Red indicates that the battery must be replaced or that the battery is disconnected. See <i>Battery Replacement</i> . Pressing this button will silence the audible alarm. See <i>Alarm Silence Button</i> .

### Automatic Self-Test

The unit automatically performs a self-test 31 hours after initial installation. Following this, a battery self-test will occur every 30 days. See *Alarm Silence Button* for manual self-test information.

### Audible Alarm

Explanation	Description
On Battery	Four beeps in four seconds will be emitted one time only. This alarm will sound when the utility power is lost and the unit goes on battery power.
Low Battery Voltage	Every five minutes, four beeps in four seconds will be emitted. This alarm will sound when operating on battery and the battery voltage has dropped below threshold, indicating that less than 20% of available runtime remains.
Replace Battery	Every fifteen minutes, there will be a quarter-second beep when the battery fails the automatic self-test.



## Alarm Silence Button

The audible alarms may be silenced by utilizing the dual function Replace Battery/Alarm Silence LED/button .





Function	Button Operation (Press and hold for:)	Description
Replace Battery- Temporarily Enable/Disable	<4 seconds	If the alarm has been silenced, the unit will emit one quick beep. If the alarm has been enabled, two quick beeps will be emitted.
Replace Battery- Permanently Enable/Disable	8-12 seconds	If the alarm has been silenced, the unit will emit one quick beep. If the alarm has been enabled, two quick beeps will be emitted.
Battery Self-Test- Enable/Disable	4-8 seconds	If the self-test has been enabled, three beeps will be emitted. If the self-test cannot be enabled, a single beep will be emitted.* If the battery self-test has been canceled, the unit will emit four beeps.

\*A battery self-test cannot be enabled unless the following conditions have been met.

1. Battery has been charged for at least 31 hours.
2. The unit has been on utility power for more than 12 hours.
3. Temperature is between 0 and 50°C.

## Output Power and Communication Signals

The PowerShield communication signals are isolated from its internal circuitry via open collector opto-coupled transistors. The connection labeled “Signal Return” is a common return point for all communication signals. In the typical application, the attached equipment digital ground connects to Signal Return, and pull-up resistors turn the open collector signals into logic levels.

—Vo +	+Voltage output
—Vo -	– Voltage output
—SIG RTN 	Signal return.
—ON BATT 	Low when operating from utility line. Open when operating from battery.
—REPLACE BATT 	Low when battery is charged. Open when battery fails the Self-Test.
—BATT MISSING 	Low when battery is present. Open when battery is missing.
—LOW BATT 	Low when battery is near full charge capacity. Open when operating from a battery with less than 20% of available runtime remaining.

# Chapter 4: Maintenance, Service, Contact Information, and Warranty

## Battery Replacement

This unit has an easy to replace, hot-swappable battery. Replacement is a safe procedure, isolated from electrical hazards. You may leave the unit and connected equipment on for this procedure.

During the self-test, battery removal and replacement are not recommended. For self-test disabling, see *Alarm Silence Button*.

Replace the spent battery with APC replacement battery RBC2. See your dealer or refer to the APC Web site, [www.apc.com](http://www.apc.com), for information on replacement batteries.

For battery replacement, see *Battery Installation*.



**Once the battery is disconnected, the connected equipment is not protected from power outages.**



**Be sure to deliver spent batteries to a recycling facility found on the *Used Battery Return Facilities* list included with RBC2.**

## Service

APC makes every effort to ensure parts and equipment arrive in working condition. Occasionally, it may be necessary to return parts and equipment that are not in working condition.

If the PowerShield requires service, follow these steps:

1. Contact APC Customer Support through the APC Web site at [www.apc.com](http://www.apc.com).

Note the product model number, the serial number, and the date purchased. If you call APC Customer Support, a technician will ask you to describe the problem and try to solve it over the phone. If this is not possible, the technician will issue a Returned Material Authorization Number (RMA#).

If the product is under warranty, repairs are free. If not, there is a repair charge.

Procedures for servicing or returning products may vary internationally. Refer to the APC Web site. Select the appropriate country from the country selection field. Select Support from the tab at the top of the web page.

2. Pack the product in its original packaging.  
Pack the unit properly to avoid damage in transit. Never use Styrofoam beads for packaging. Damage sustained in transit is not covered under warranty.
3. Mark the RMA# on the outside of the package.

4. Return the unit by insured, prepaid carrier to the address given to you by Customer Support.



**Always DISCONNECT THE BATTERY before shipping in compliance with U.S. Department of Transportation (DOT) regulations.**

## **APC Worldwide Customer Support**

Customer support for this or any other APC product is available at no charge in any of the following ways:

- Refer to the APC Web site to access documents in the APC Knowledge Base and to submit customer support requests.
  - www.apc.com** (Corporate Headquarters)  
Connect to localized APC Web sites for specific countries, each of which provides customer support information.
  - www.apc.com/support/**  
Global support searching APC Knowledge Base and using e-support.
- Contact an APC Customer Support center by telephone or e-mail.  
Local, country-specific centers:  
go to **www.apc.com/support/contact** for information.

Contact the APC representative or other distributor from whom you purchased your APC product for information on how to obtain local customer support.

## **Limited Warranty**

American Power Conversion (APC) warrants its products to be free from defects in materials and workmanship for a period of two years from the date of purchase. Its obligation under this warranty is limited to repairing or replacing, at its own sole option, any such defective products. To obtain service under warranty you must obtain a Returned Material Authorization (RMA) number from customer support. Products must be returned with transportation charges prepaid and must be accompanied by a brief description of the problem encountered and proof of date and place of purchase. This warranty does not apply to equipment that has been damaged by accident, negligence, or misapplication or has been altered or modified in any way. This warranty applies only to the original purchaser who must have properly registered the product within 10 days of purchase.

EXCEPT AS PROVIDED HEREIN, AMERICAN POWER CONVERSION MAKES NO WARRANTIES, EXPRESSED OR IMPLIED, INCLUDING WARRANTIES OF MERCHANTABILITY AND FITNESS FOR A PARTICULAR PURPOSE. Some states do not permit limitation or exclusion of implied warranties; therefore, the aforesaid limitation(s) or exclusion(s) may not apply to the purchaser.

EXCEPT AS PROVIDED ABOVE, IN NO EVENT WILL APC BE LIABLE FOR DIRECT, INDIRECT, SPECIAL, INCIDENTAL, OR CONSEQUENTIAL DAMAGES ARISING OUT OF THE USE OF THIS PRODUCT, EVEN IF ADVISED OF THE POSSIBILITY OF SUCH DAMAGE. Specifically, APC is not liable for any costs, such as lost profits or revenue, loss of equipment, loss of use of equipment, loss of software, loss of data, costs of substitutes, claims by third parties, or otherwise.

# Chapter 5: Regulatory Approvals

## CP16 models

## CP27 models



### EC Declaration of Conformity

2005  
Date of product declaration

We, the undersigned, declare under our sole responsibility that the equipment specified below conforms to the following standards and directives:

**Standards to Which Conformity Declared:** EN60950-1; IEC60950-1; EN55022; EN55024; EN61000-3-2, 3-3, 4-2, 4-3, 4-4, 4-5, 4-6, 4-11

**Application of Council Directives:** 73/23/EEC; 93/68/EEC; 89/336/EEC

**Type of Equipment:** Battery Back-Up, Switch-Mode Power Supply

**Model Numbers:** CP27

**Manufacturers:**

American Power Conversion  
Ballybritt Business Park  
Galway, Ireland

American Power Conversion  
2nd Street  
PEZA, Cavite Economic Zone  
Rosario, Cavite  
Philippines

APC (Suzhou) UPS Co., Ltd  
339 Suhong Zhong Lu  
Suzhou Industrial Park  
Suzhou Jiangsu 215021  
P. R. China

American Power Conversion  
Breaffry Rd.  
Castlebar  
Co Mayo, Ireland

American Power Conversion  
Lot 10, Block 16, Phase 4  
PEZA, Rosario, Cavite  
Philippines

APC Brasil LTDA.  
Al. Xingu, 850  
Barueri  
Alphaville/Sao Paulo  
06455-030 Brazil

American Power Conversion  
132 Fairgrounds Rd.  
West Kingston, RI 02892 USA

American Power Conversion  
1600 Division Rd.  
West Warwick, RI 02892 USA

American Power Conversion  
Lot 3, Block 14, Phase 3  
PEZA, Rosario, Cavite  
Philippines

American Power Conversion  
40 Catamore Blvd.  
East Providence, RI 02914 USA

APC India Pvt. Ltd.  
187/3, 188/3, Jigani Industrial Area, Jigani  
Bangalore, 562106  
Karnataka  
India

**Importer:**

American Power Conversion (A. P. C.) b. v.  
Ballybritt Business Park  
Galway, Ireland

**Place:** Galway, Ireland

Ray S. Ballard, Managing Director, Europe

5 Jan 05

Entire contents copyright 2006 by American Power Conversion Corporation. All rights reserved. Reproduction in whole or in part without permission is prohibited.

APC, the APC logo and PowerShield are registered trademarks of American Power Conversion Corporation. All other trademarks are the property of their respective owners.