

CyberPower®

User's Manual

OLS6000ERTXL3U
OLS10000ERTXL3U

CyberPower Systems Inc.
www.cyberpower.com

K01-C000112-03

CONTENT :

1. Safety	1
1.1. Installation	1
1.2. Operation	1
1.3. Maintenance, Servicing and Faults	2
1.4. Transport	3
1.5. Storage	3
1.6. Standards	3
2. Description of Commonly Used Symbols	4
3. Introduction	4
3.1. Feature	4
3.2. Electrical Specifications	5
3.3. Operating Environment	7
3.4. Dimensions and Weights	7
4. Unpacking	7
5. Hardware Installation	9
5.1. Rackmount Installation	9
5.2. Vertical/Tower Installation	11
6. Electrical Installation	15
6.1. Power Wires Installation	15
6.2. Operating Procedure for Connecting with The External Battery Pack	18
6.3. EPO Connection	19
7. Operation	20
7.1. Display Panel	20
7.2. Turning On and Turning Off UPS	22
7.3. LCD Operation	23
8. Special Function	28
8.1. ECO Function	28
8.2. Converter Function	28
8.3. Parallel Function	29
9. Trouble Shooting	33
9.1. Trouble Shooting According To Warning Indication	33
9.2. Trouble Shooting According To Fault Indication	35
9.3. Trouble Shooting In Else Cases	36

10. Battery Maintenance	36
11. Communication Port	37
11.1. USB Interface	37
11.2. RS 232 Interface	37
11.3. Intelligent slot	37

1. Safety

Please read carefully the following user manual and the safety instructions before installing the unit or using the unit!

1.1. Installation

- This is permanently connected equipment, and it must be installed by qualified maintenance personnel.
- Condensation may occur if the UPS is moved directly from a cold to a warm environment. The UPS must be absolutely dry before being installed. Please allow an acclimatization time of at least two hours.
- Do not install the UPS near water or in damp environment.
- Do not install the UPS where it would be exposed to direct sunlight or near heat.
- Do not connect appliances or items of equipment which would overload the UPS (e.g. laser printers, etc.) to the UPS output.
- Do not block ventilation openings in the UPS's housing. Ensure allow at least 0.5m of space on front and rear of the UPS.
- Place cables in such a way that no one can step on or trip over them.
- Connect UPS with the earth reliably before connecting to the building wiring terminal, and external battery source must also be earthed.
- An integral single emergency switching device which prevents further supply to the load by the UPS in any mode of operation should be provided in the building wiring installation.
- An appropriate disconnect device as short-circuit backup protection should be provided in the building wiring installation.
- The equipment is powered by two sources: the mains source, the internal battery or the external battery source.
- With the installation of the equipment, the sum of the leakage current of the UPS and the connected load does not exceed 5% of rated value of input current.

1.2. Operation

- Do not disconnect the main cable on the UPS or the building wiring terminals during operation since this would remove the protective earth from the UPS and all connected loads.
- The UPS output terminal block may still be electrically lived even if the UPS is

not connected to the building wiring terminal, for there is internal current source (batteries).

- In order to fully disconnect the UPS, first turn the input breaker in the "OFF" position, then disconnect the mains lead.
- Indiscriminate operation of switches may cause output loss or damage to equipment. Refer to instruction before conducting any control.
- While the UPS work as a parallel system, the external parallel cable should be reinforced insulation.
- Ensure that no liquid or other foreign objects can enter the UPS.

1.3. Maintenance, Servicing and Faults

- Do not remove the enclosure since the UPS operates with hazardous voltages. It is to be serviced only by qualified maintenance personnel.
- **Caution!** Risk of electric shock. Even after the unit is disconnected from the mains power supply (building wiring terminal) components inside the UPS are still connected to the battery which are potentially dangerous.
- Before carrying out any kind of service or maintenance, isolate UPS and disconnect the batteries. Verify that no current is present and no hazardous voltage exists in the capacitor or BUS capacitor.
- Batteries must be replaced only by qualified personnel.
- Batteries have a high short-circuit current and pose a risk of shock. Take all precautionary measures specified below and any other necessary measures when working with batteries:
 - remove all jewellery, wristwatches, rings and other metal objects
 - use only tools with insulated grips and handles.
- When changing batteries, replace with the same quantity and the same type of batteries.
- Do not attempt to dispose of batteries by burning them. It could cause explosion.
- The UPS may be connected to external battery package. Proper disposal of batteries is required. Refer to your local codes for disposal requirements.
- Do not open or destroy batteries. Effluent electrolyte can cause injury to the skin and eyes. It may be toxic.
- Replace the fuse only by a fuse of the same type and of the same spec in order to avoid fire hazards.

1.4. Transport

Please transport the UPS only in the original packaging to protect against shock and impact.

1.5. Storage









The UPS must be stockpiled in the room where is ventilated and dry.

1.6. Standards

* Safety	
IEC/EN 62040-1	
* EMI	
Conducted Emission.....:IEC/EN 62040-2	Category C3
Radiated Emission.....:IEC/EN 62040-2	Category C3
*EMS	
ESD.....:IEC/EN 61000-4-2	Level 3
RS.....:IEC/EN 61000-4-3	Level 3
EFT.....:IEC/EN 61000-4-4	Level 4
SURGE.....:IEC/EN 61000-4-5	Level 4
Low Frequency Signals.....:IEC/EN 61000-2-2	
Warning: This is a product for commercial and industrial application in the second environment-installation restrictions or additional measures may be needed to prevent disturbances.	

2. Description of Commonly Used Symbols

Some or all of the following symbols may be used in this manual. It is advisable to familiarize yourself with them and understand their meaning:

Symbol and Explanation			
Symbol	Explanation	Symbol	Explanation
	Alert you to pay special attention		Caution of high voltage
	Alternating current source(AC)		Direct current source(DC)
	Turn on or turn off the UPS		Protective ground
	Recycle		Do not dispose with ordinary trash

3. Introduction

This On-Line series is an uninterruptible power supply incorporating double-converter technology. It provides perfect protection specifically for computer equipments, communication servers, and data centers.

The double-converter principle eliminates all mains power disturbances. A rectifier converts the alternating current from the mains power to direct current. On the basis of this DC voltage, the inverter generates an AC sinusoidal voltage, which constantly supplies the loads. In the event of power failure, the maintenance-free batteries power the inverter.

3.1.Feature

This series UPS is a new generation of UPS, which provides the outstanding reliability, and most cost-performance ratio in the industrial. Following benefit the product has:

- True online double-conversion technology with high power density, frequency

independence and generator compatibility.

- High input power factor ≥ 0.99 , overall high efficiency $\geq 92\%$, save power and wiring expense. Low input current distortion, avoid power pollution.
- Output power factor is 0.9, perfect output sine waveform, suitable almost all critical equipment.
- Outstanding adaptability to the worst mains input condition. Extra wide input voltage, frequency range and waveform, avoid excessive dissipating limited battery energy.
- Internal charger could be up to 4Amps to decrease recharging time of battery.
- Automatically select charging current through the external Battery Type and external battery pack setting.
- N+X parallel redundancy to increase the reliability and flexibility. Number of parallel operating UPS is up to 4.
- ECO mode with high efficiency $\geq 96\%$, save power expense for user.
- Start-able without battery.

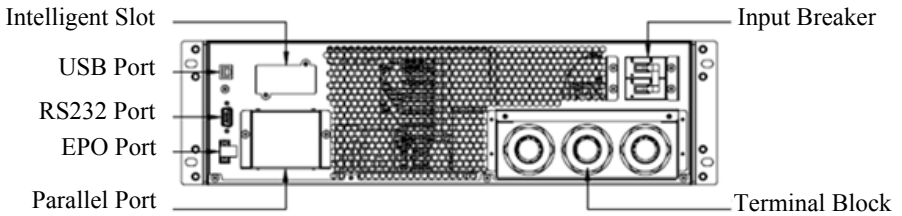

Fig.3-1 The rear view of OLS6000/10000ERTXL3U

3.2. Electrical Specifications

Model	OLS6000ERTXL3U	OLS10000ERTXL3U
Input		
Phase	Single	
Voltage Range	110~276Vac (Depends on load level)	
Frequency Range	50/60 \pm 10%Hz	
Rated Current	36A	55A

Power Factor	≥ 0.99 @ full load	
Battery		
Rated Voltage	240Vdc	
Rated Current	28A	47A
Output		
Power Rating	6kVA/5.4kW	10kVA/9kW
Voltage*	208/220/230/240Vac	
Frequency	Synchronized 50/60 \times (1 \pm 10%)Hz @Line mode 50/60 \times (1 \pm 0.1%)Hz @Battery mode	
Wave Form	sine	
Load Type	PF 0.5~1, lagging	
THDV	$\leq 2\%$ @ full linear load $\leq 5\%$ @ full nonlinear load	
Over Load**	Line mode: 10 min 105%~125% 1 min 125%~150% 10 s 150%~170% 100ms >170% Battery mode: 2 min 105%~125% 30 s 125%~150% 100ms >150%	

*The load capacity would be derated to 90% automatically when the output voltage is adjusted to 208Vac.

**The overload capacity would be derated automatically in Line mode while the circumstance temperature is larger than 35 degree.

3.3. Operating Environment



Temperature	Humidity	Altitude	Storage
0°C~40°C	<95%	<1000m	-15°C~50°C







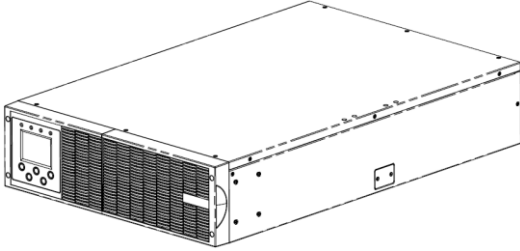
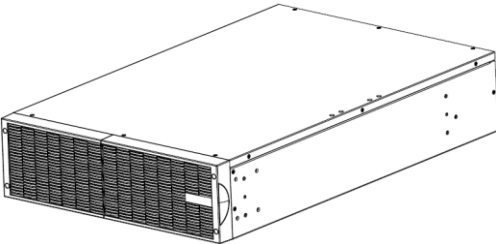

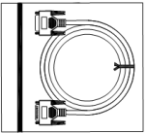
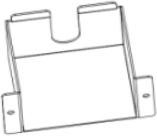

Note: The load capacity should be derated 1% every 100m heightened on the basis of 1000m.

3.4. Dimensions and Weights

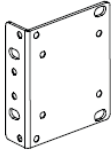
Model	Dimensions W×H×D(mm)	Net Weight(kg)
OLS6000ERTXL3U	438 x 130.5 x 680	17.5
OLS10000ERTXL3U	438 x 130.5 x 680	20

4. Unpacking

	
Power module*	
	
Battery module (Optional)	User's manual

			
RS232 cable (optional)	USB communication cable	Parallel cable	Parallel port cover plate
			
Rackmount left rail	Rackmount right rail	Rackmount ears (Stands)*2PCS	Terminal*11PCS
			
Flat head screws: M4X8L*8PCS	Pan head screws: M5X12L*12PCS	Screw hole dust covers*8PCS	Plastic washers *8PCS

***PowerPanel®Business Edition software is available on our website. Please visit www.cyberpower.com and go to the Software Section for free download.**

CAUTION! Inspect the appearance of the UPS to see if there is any damage during transportation. Do not turn on the unit and notify the carrier and dealer immediately if there is any damage or lacking of some parts.

5. Hardware Installation

CAUTION! To prevent the risk of fire or electric shock, only use the supplied hardware to attach the mounting brackets.

5.1. Rackmount Installation

UPS systems can be mounted in a rackmount or vertical tower orientation. This versatility is especially important to growing organizations with changing needs that value having the option to position a UPS on a floor or in a rackmount system. Please follow the instructions below for the respective mounting methods.

Step1.Rackmount ears installation:

- 1) Attach the two rackmount ears to the Power module using the provided screws M4X8L*8pcs.

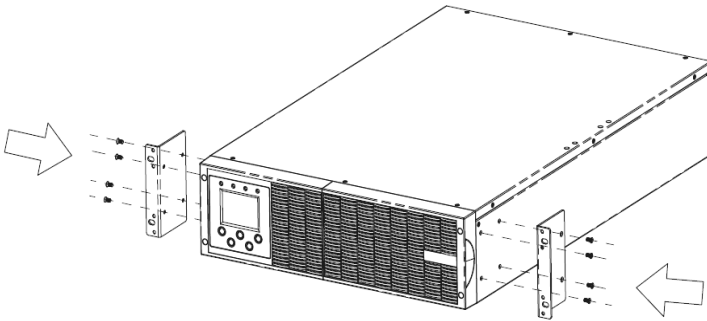

- 2) Insert dust cover into the rackmount ear screw holes that are not being used.

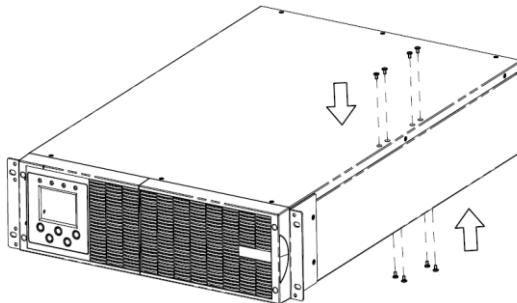

Step2.Rackmount rails installation:

- 1) The rails adjust to mount in 48-cm (19-inch) panel racks from 52 to 91.5cm (20.5 to 36 inches) deep. Select the proper holes in the rack for positioning the Power module in the rack. The Power module takes up position 1 through position 9.
- 2) Attach the rackmount rail to your rack with two M5X12L screws and two plastic washers at the front of the rack. (Located in position 1 & position 6) Do not tighten the screws. Adjust the rail size on the rail assembly of your rack.

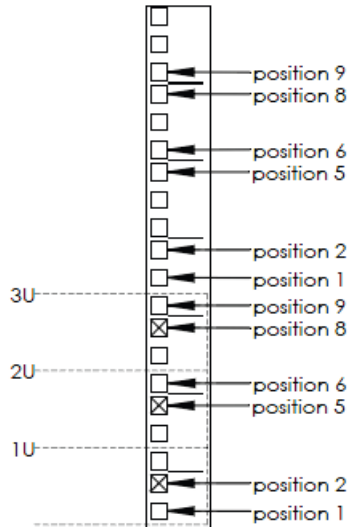

Secure the rail to the rear of the rack with two M5X12L screws and two plastic washers. Tighten all screws at the front and rear of the rail. Once completed, perform the same steps for assembling the other rackmount rail.

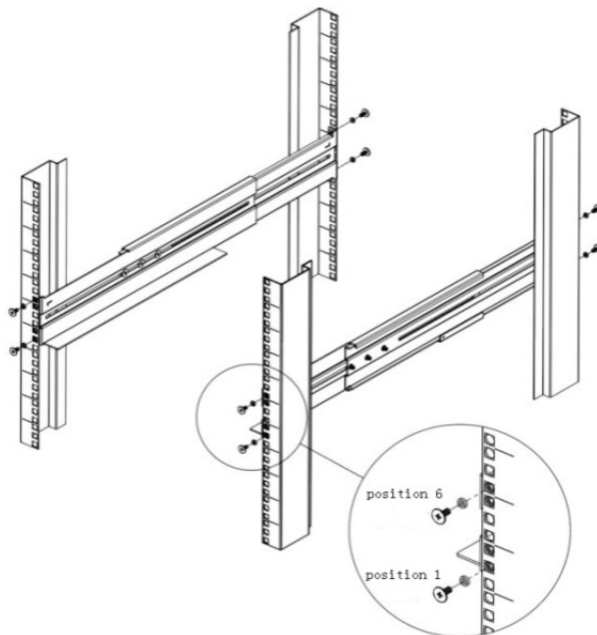

Step3.Install the Power module on the rack:

- 1) Place the Power module on a flat stable surface with the front of the unit facing toward you. Secure the Power module to your rack with four M5X12L screws at the front of the rack. (Located in position 2 & position 8).

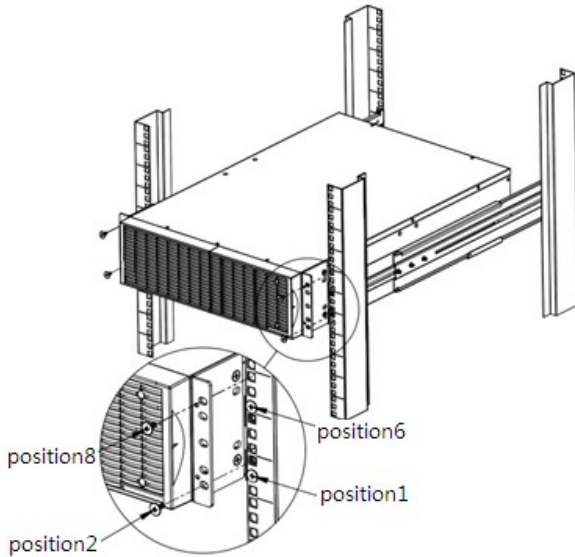

- 2) Once completed, perform the same steps for the external battery pack.

CAUTION! The external battery pack must be installed below the Power module.

5.2. Vertical/Tower Installation

Step1.Rotate the multifunction LCD module:

- 1) Unscrew the right panel of the Power module. Separate the right panel from Power module.

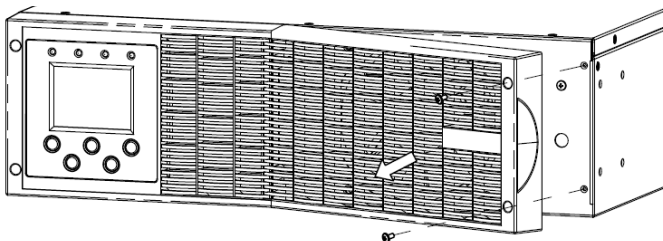

- 2) Unscrew the left panel of the Power module. Separate the left panel from Power module.

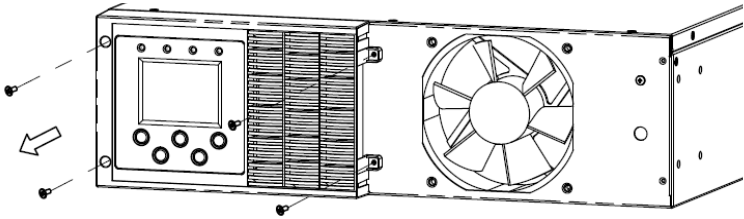

- 3) Rotate the LCD module to the left. Reinstall it for a tower configuration .

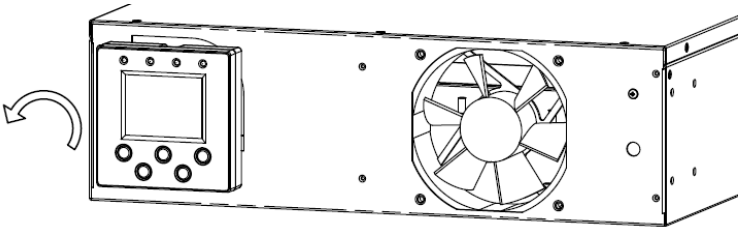

- 4) Last tighten the screws to fix the left panel and the right panel.

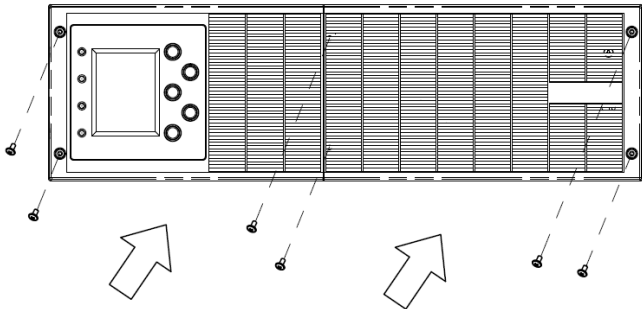

Step2.Attach the base stands:

Connection#1: Power module without external battery pack

- 1) Tighten the screws (M5X12*4pcs) of the base stands (rackmount ears) onto the bottom of Power module.

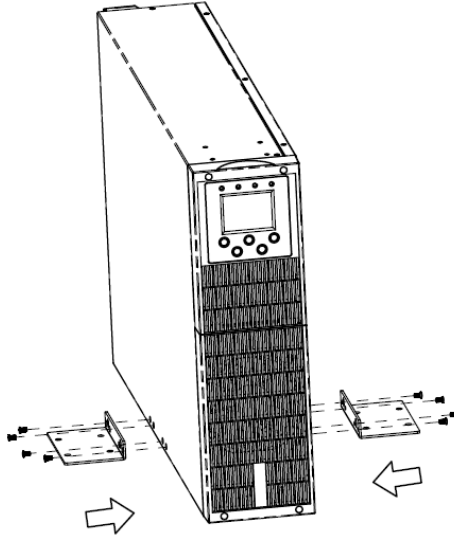

- 2) Insert dust cover into the rackmount ear screw holes that are not being used.

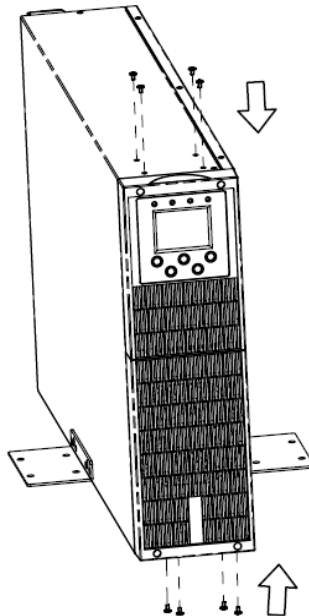

Connection#2: Power module with external battery pack

- 1) Tighten the screws (M5X12*4pcs) of the base stands (rackmount ears) onto the bottom of Power module and external battery pack.

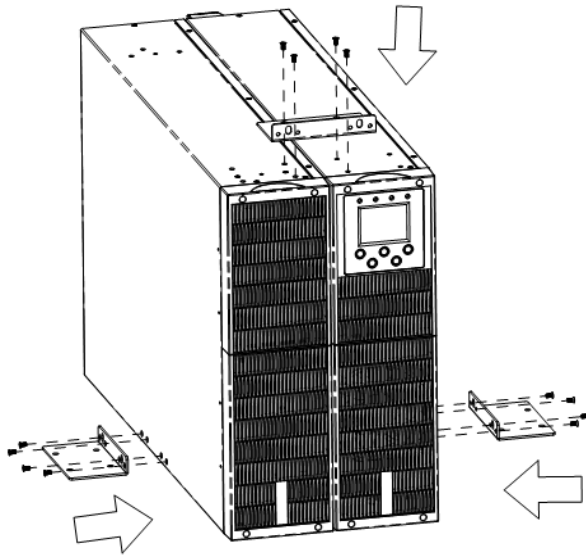

- 2) Insert dust cover into the rackmount ear screw holes that are not being used.

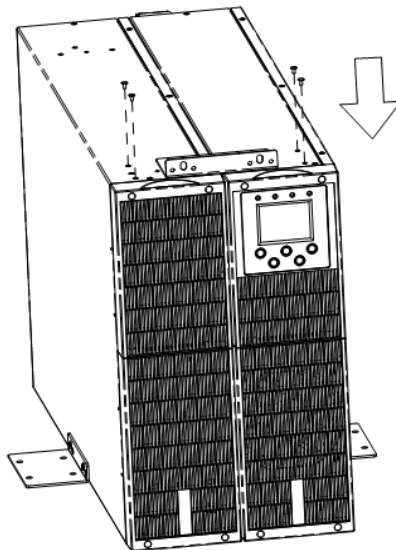

6. Electrical Installation

6.1. Power Wires Installation

The system must be installed and wired only by qualified electricians in accordance with applicable safety regulations!

For safety, please cut off the mains power switch before installation!

When installing the electrical wiring, please note the nominal amperage of your incoming feeder.

Use cable cross section and protective device specification:

Model	OLS6000ERTXL3U	OLS10000ERTXL3U
Protective earthing conductor Min cross section	6mm ² (UL101510AWG)	10mm ² (UL1015 8AWG)
Input L, N, G Min conductor cross section	6mm ² (1015 10AWG)	10mm ² (UL1015 8AWG)
Input breaker	40A/250Vac	63A/250Vac
Output L,N, Min conductor cross section	6mm ² (1015 10AWG)	10mm ² (UL1015 8AWG)
External Battery Cabinet Positive Pole(+), Negative pole(-), Min conductor cross section	6mm (1015 10AWG)	10mm ² (UL1015 8AWG)
External Battery Cabinet Fuse in Positive Pole(+), Negative pole(-)	30A/240Vdc	60A/240Vdc
External Battery Cabinet Breaker in Positive Pole(+), Negative pole(-)	32A/240Vdc	60A/240Vdc
Torque for fixing above terminals	3.95~4.97Nm (35~44 lb in)	

- 1) It is suggested to install an external isolating device against current backfeed between mains input and Power module. After the device is installed, it must add a warning label with the following wording or the equivalent on the external AC contactor: **RISK OF VOLTAGE BACKFEED**. Isolate the Power module before operating on this circuit, then check for hazardous voltage between all terminals.

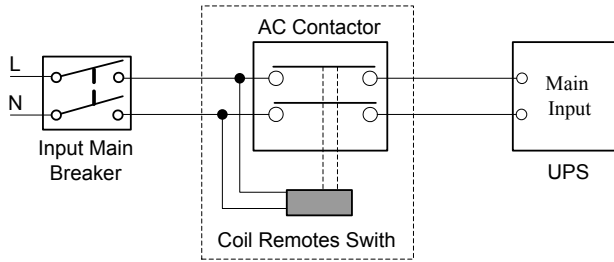
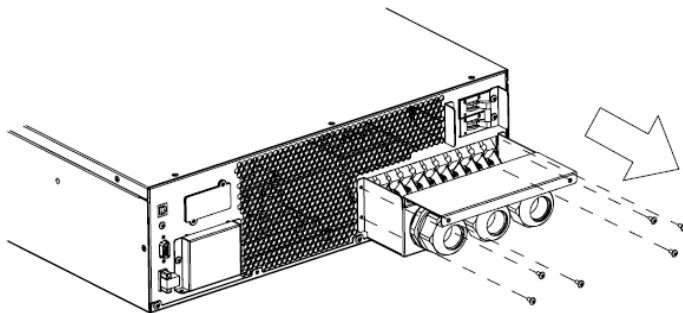

Fig.6-1 Typical external isolating device installation

- 2) No matter the Power module is connected to the mains power or not, the output of the Power module may be electrically live. The parts inside the unit may still have hazardous voltage after turning off the Power module. To make the Power module have no output, turn off the Power module, and cut off the mains power supply, wait the Power module shut down completely, finally cut off the battery connection.
- 3) Open the terminal block cover located on the rear panel of Power module, please refer to the appearance diagram.



- 4) For OLS6000ERTXL3U, it is recommended to select the UL1015 10AWG/6mm² or other insulated wire which complies with AWG Standard for the Power module input and output wirings.
- 5) For OLS10000ERTXL3U, it is recommended to select the UL1015 8AWG/10mm² or other insulated wire which complies with AWG Standard for the Power module input and output wirings.
- 6) Ensure the capacity of mains power supply. Do not use the wall receptacle as

the input power source for the Power module, as its rated current is less than the Power module's maximum input current. Otherwise the receptacle may be burned and destroyed.

- 7) The protective earth ground wire should be installed first according to the following diagram. It is better to use green wire or green wire with yellow ribbon wire.
- 8) Connect other input and output wires to the corresponding input and output terminals according to the following diagram.
- 9) It is requested to use the accessorial terminal splices which can be compacted on the wires tightly, to ensure the connection between the wires and the terminal block is reliable.

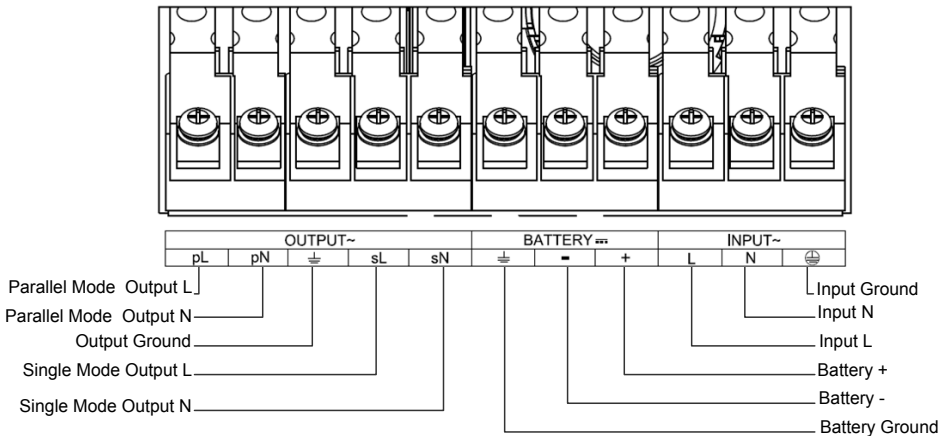

Fig.6-2 Input and output terminal block wiring diagram

Important notes:

If the Power module is used in single mode, the output must be connected to sL and sN.

If the Power module is used in parallel mode, the output must be connected to pL and pN.

- 10) Install an output breaker between the output terminal of Power module and the load, and the breaker should with leakage current protective function if necessary.
- 11) Turn off all the loads first before connecting the load with the Power module, then perform the connection and finally turn on the loads one by one.

- 12) After completing the installation, please check the wires to make sure all were connected correctly and tightly.
- 13) Suggest charging the batteries for 8 hours before use. After Installation, turn on the mains power switch and turn the input breaker in the "ON" position, the Power module will charge the batteries automatically. It can also use the Power module immediately without charging the batteries, but the backup time may be less than the standard value.
- 14) If it is necessary to connect the inductance load such as a monitor or a laser printer to the Power module, the start-up power should be used for calculating the capacity of the Power module, as its start-up power consumption is too big to make the Power module which capacity is small fail easily.

6.2. Operating Procedure for Connecting with The External Battery Pack

- 1) The nominal DC voltage of external battery pack is 240Vdc. To achieve longer backup time, it is possible to connect multi-battery packs, but the principle of "same voltage, same type" should be strictly followed.
- 2) For OLS6000ERTXL3U, select the UL1015 10AWG/6mm² respectively or other insulated wire which complies with AWG Standard for the UPS battery wirings.
- 3) For OLS10000ERTXL3U, select the UL1015 8AWG/ 10mm² respectively or other insulated wire which complies with AWG Standard for the UPS battery wirings.
- 4) The external battery pack must be independent for each Power module. It is forbidden that two Power modules use one external battery pack.
- 5) The procedure of installing battery pack should be complied with strictly. Otherwise it may encounter the hazardous of electric shock.
 - 1) Ensure the Power module is not powered on and the mains input breaker is set in the "OFF" position.
 - 2) A DC breaker must be installed between the external battery pack and the UPS. The capacity of breaker must be not less than the data specified in the general specification.
 - 3) Set the external battery pack breaker in "OFF" position and connect the 20 pieces of batteries in series.
 - 4) Connect the external battery pack to the battery terminals. Check the

polarity of connection is correct.

- 5) Set breaker of the battery pack in the "ON" position.
- 6) Set the mains input breaker in the "ON" position, the Power module would power on and start to charge the battery pack.

6.3. EPO Connection

EPO (Emergency power off): when the emergency occurs, such as the failure of load, the UPS can cut off the output at once by operating the EPO port manually.

The connection:

Normally the EPO connector is closed with a wire on the rear panel, which is supplied in the accessory. Once the connector is open, the UPS would stop the output and enter EPO status (Fig.6-3).

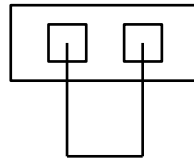
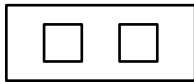

Fig.6-3 Enable the EPO status

Fig.6-4 Disable the EPO status

To recover to normal status, first EPO connector should be closed(Fig.6-4), and enter LCD menu (illustrated in the chapter of 7.3) to clear EPO status, then UPS would stop alarm and recover to Bypass model. And UPS needs be turned on by manual operation.

7. Operation

7.1. Display Panel

The UPS has a five-button, dot matrix LCD with white text and a blue background. Besides the LCD, the UPS has four colorized LED to provide more convenient information.

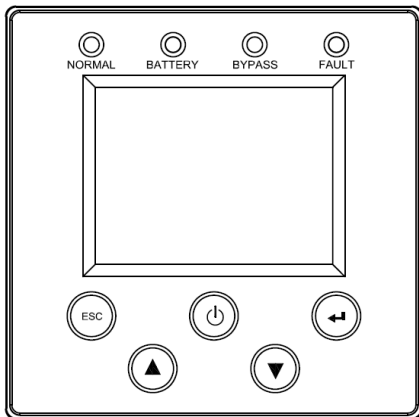





Fig.7-1 LCD Panel

Control button functions:

The Button	Function	illustration
	Power on	When the unit is no power and has connected with battery, press this button more than 200ms to power on
	Turn on	When the unit is powered on and is in Bypass mode, press this button more than 1s to turn on
	Turn off	When the unit has been turned on, press this button more than 3s to turn off
	Enter	Press this button more than 200ms to confirm current selection or enter the current selection window
ESC	Exit	Press this button more than 200ms to cancel current selection and return to previous menu.
	UP	Press this button more than 200ms to move the focus to the up menu
	Down	Press this button for more than 200ms to move the focus to the down menu

LED definition:

UPS state	Normal (Green LED)	BATTERY (Yellow LED)	BYPASS (Yellow LED)	FAULT (Red LED)
Bypass mode without output			★	□
Bypass mode with output			○	□
Line mode	○			□
Battery mode	○	○		□
ECO mode	○		○	□
Battery test mode	※	※	※	※
Turn on	※	※	※	※
Fault mode			□	○
Warning mode	□	□	□	★

Note: ○: Lightened constantly

※: #1-#4 Lightened circularly

★: Flashing

□: Depended on the fault/warning status or other status

Alarm definition:

UPS condition	Buzzer status
Fault active	Continuous
Warning active	Beep every second
Battery mode	Beep every 4 seconds, if battery low, buzzer Beep every second
Bypass mode	Beep every 2 minutes
Overload	Beep twice every second

The UPS provides useful information about UPS itself, load status, battery, events, identification, and settings through the front panel display.

During powering on, the LCD would display the CyberPower logo for several seconds and then enter to the default page which shows the UPS status summary.

On the UPS status screen it provides the following information:

- Status summary, including mode, load, battery and utility
- Alarm status, if any is present.
- Fault status, if any is present.
- Output parameter, including output voltage, current and frequency.
- Input parameter, including input voltage and frequency.
- Bypass parameter, including bypass voltage and frequency.
- Power parameter, including output VA and watt.
- Battery parameter, including battery capacity, voltage and remain time.

7.2. Turning On and Turning Off UPS

Attention: The UPS could only be turning on while connecting with the mains at the first time.

Attention: Please switch off the connected loads first before turning on the UPS, and switch on the loads one by one after the UPS is turned on. Switch off all of the connected loads before turning off the UPS.

Turning on UPS with mains:

- 1) Check all the connection is correct. Check the breaker of external battery pack is in "ON" position.
- 2) Set input breaker in "ON" position. At this time the fan begins to rotate, LCD will show "CyberPower". Then LCD will show the default UPS status summary screen after UPS finishing self-test.
- 3) By pressing button  continuously for more than 1 second, the buzzer will beep for 1s, UPS starts to turn on.
- 4) A few seconds later, the UPS turns into Line mode. If the mains power is abnormal, the UPS will transfer to Battery mode without output interruption of the UPS.

Turning on UPS without mains:

- 1) Check all the connection is correct. Check the breaker of external battery pack is in "ON" position.
- 2) By pressing button  continuously for more than 200ms, the UPS would be

powered on. At this time the fan begins to rotate, LCD will show "CyberPower". Then LCD will show the default UPS status summary screen after UPS finishing self-test.

- 3) By pressing button  continuously for more than 1s, the buzzer will beep for 1s, UPS starts to turn on.
- 4) A few seconds later, the UPS turns into Battery mode. If the mains power comes back, the UPS will transfer to Line mode without output interruption of the UPS.

Turning off UPS with mains:

- 1) To turn off the inverter of UPS by pressing button  continuously for more than 3s and the buzzer will beep for 3s. The UPS will turn into Bypass mode at once.
- 2) When completing the above action, UPS output voltage is still present. In order to cut off the UPS output, simply cut off the mains power supply. A few seconds later, LCD display shuts down and no output voltage is available from the UPS output terminal.



Turning off UPS without mains:





- 1) To power off the UPS by pressing button  continuously for more than 3s, and the buzzer will beep 3s. The UPS will cut off the output at once.
- 2) A few seconds later, LCD shuts down and no voltage is available from the UPS output.

7.3. LCD Operation

Except the default UPS status summary screen, the user could get more useful information about UPS current status, old events which ever occurred, UPS own identification, and could change the settings to fit the user own requirements, optimize the function of UPS.

The status screen:

In the UPS status screen, when pressing  or  >200ms the detailed information about UPS information that include alarm, fault output, input, bypass, load and battery parameter would be shown, See Fig.7-2.

when pressing  > 200ms the main menu would be shown. In fault or alarm screen, when pressing  > 200ms, the other alarm or fault would be shown by pressing  or  >200ms, and press  >200ms the display would return to status screen. The main menu includes four branches: UPS control menu, setting

menu, event menu and identification menu. See Fig.7-3.

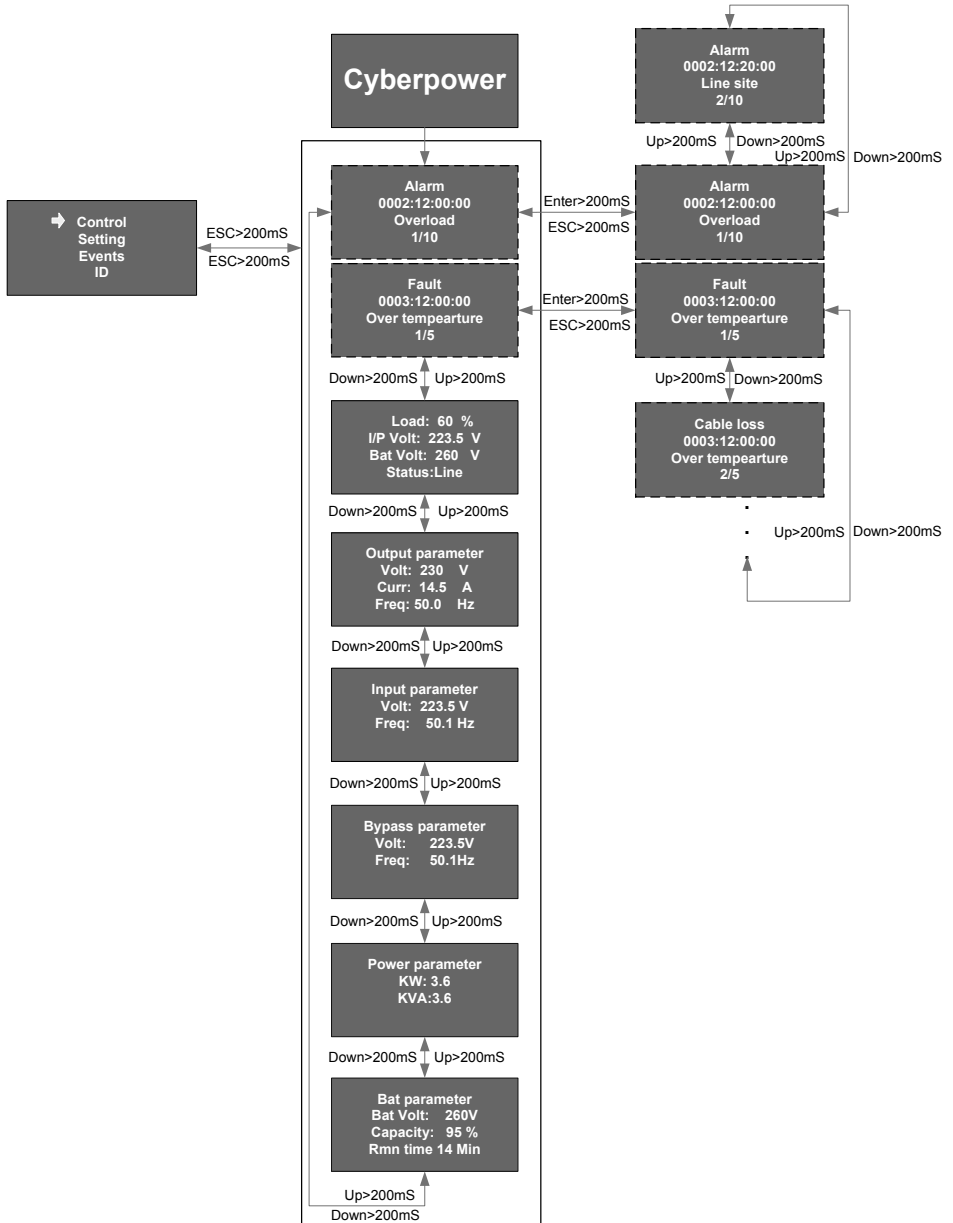

Fig.7-2 UPS status menu

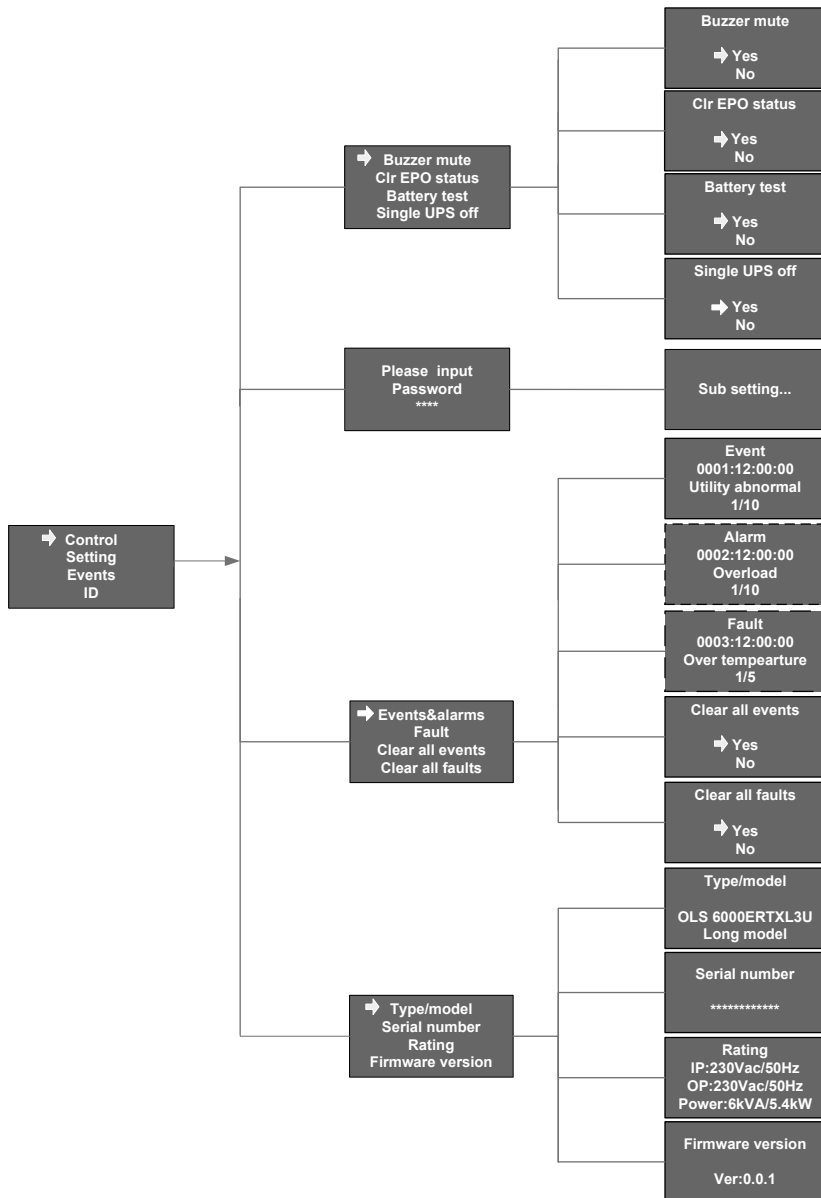



Fig.7-3 Main menu

The control menu:

By pressing  , enter the menu of "Control". The display would enter the next control menu screen.

- 1) Buzzer mute
- 2) Battery test: is one command to control all UPS in a parallel system to do the battery test at the same time.
- 3) Clear EPO status: once EPO status is enabled, the UPS output would be cut off. To recover to normal status, first EPO connector should be closed, and enter this menu to clear EPO status, then UPS would stop alarm and recover to Bypass model. And UPS needs be turned on by manual operation.
- 4) Single UPS off: is one command to turn off one UPS which is operated currently in parallel system, and other UPS continue working to supply the load in the parallel system.

The setting menu:

Please contact your local distributor for further information before using the settings. Some settings would change the specification, and some settings would enable or disable some functions. The unsuitable option set by user may result in potential failures or protecting function loss, even directly damage the load, battery or UPS. The most of settings could only be done while UPS is in Bypass mode.

Submenu item	Optional Values	Default Value
User password*	enabled/disabled	enabled
Audio alarm	enabled/disabled	enabled
Site wiring fault alarm	enabled/disabled	enabled
Ambient temperature warning	enabled/disabled	enabled
DC start	enabled/disabled	enabled
Auto Restart	enabled/disabled	enabled
Automatic overload restart	enabled/disabled	enabled
Auto Bypass	enabled/disabled	enabled

Short circuit clearance	enabled/disabled	disabled
Power strategy**	normal/ECO/converter	normal
Rated output voltage	208/220/230/240V	230V
Output frequency	50/60Hz	50Hz
Bypass voltage low range	10%,15%,20%	15%
Bypass voltage high range	10%,15%	10%
Bypass frequency range	1%~10%	10%
ECO voltage range	10%,15%	10%
ECO frequency range	1%~10%	5%
Ext. Bat Type***	Standard/Customized	Standard
Ext. Bat Pack ****	1Packs~15Packs	1 Packs
Automatic battery tests period	0~45days	7days
Set running time	Day: hour: minute: second 0000:0000:00~9999:23:59:59	Running time
Restore default setting*****	Yes/NO	

*Password is AAAA when enabled.

**Read the chapter of 8.1 and 8.2, before using ECO or converter function. UPS need shut down, if change work mode from converter to others.

***Large current Charging when Ext. Bat Type is "Customized".

****Small current Charging when Ext. Bat Pack≤2 Packs. Large current Charging when Ext. Bat Pack >2 Packs.

*****UPS need shut down.

8. Special Function

The series UPS has some special functions, which could satisfy some special application of user. And the functions have own features, please contact your local distributor for further information before using the function.

8.1. ECO Function

Brief introduction of ECO function:

If ECO function is set to enable, after the UPS is turned on, the power used by the load is directly supplied from the mains power via internal filter while the utility power is in normal range, so the economy mode could be gained in ECO mode. Once the mains power is loss or abnormal, the UPS would transfer to Line mode or Battery mode and the load is supplied continuously.

The great virtue is overall high efficiency $\geq 96\%$ of UPS, to save power for user.

But the disadvantage is:

- 1) The load can't be protected as well as in Line mode, for the load is directly supplied from the mains;
- 2) The transfer time of UPS output from ECO mode to Battery mode is about 10ms.

So the function is not suitable to some sensitive loads, and the region where the mains power is unstable.

Set the function:

The function could be enabled through the LCD setting in Bypass mode. Enter the power strategy setting menu by following chapter of 7.3.

8.2. Converter Function

Brief introduction of Converter function:

In converter mode, the UPS would free run with fixed output frequency (50Hz or 60Hz). Once the mains power is loss or abnormal, the UPS would transfer to Battery mode and the load is supplied continuously.

The great virtue is the output frequency is fixed, which is required by some very sensitive loads. But the disadvantage is the load capacity of UPS should be derated to 60% in converter mode.

Set the function:

The function could be enabled through the LCD setting in Bypass mode. Enter the

power strategy setting menu by following chapter of 7.3.

8.3. Parallel Function

Brief introduction of the redundancy:

N+X is currently the most reliable power supply structure. N represents the minimum UPS number that the total load needs, X represents the redundant UPS number, i.e. the fault UPS number that the system can handle simultaneously. When the X is larger, the reliability of the power system is higher. For occasions where reliability is highly depended on, N+X is the optimal mode.

As long as the UPS is equipped with parallel cables, up to 4 UPS can be connected in parallel to realize output power sharing and power redundancy.

How to install a new parallel UPS system:

- 1) Before installing a new parallel UPS system, user need to prepare input and output wires, input and output breaker, main maintenance bypass switch.
- 2) Remove the cover plate of the parallel port on the UPS, connect each UPS one by one with the parallel cable, and re-screw the parallel port cover which is supplied in the accessories.

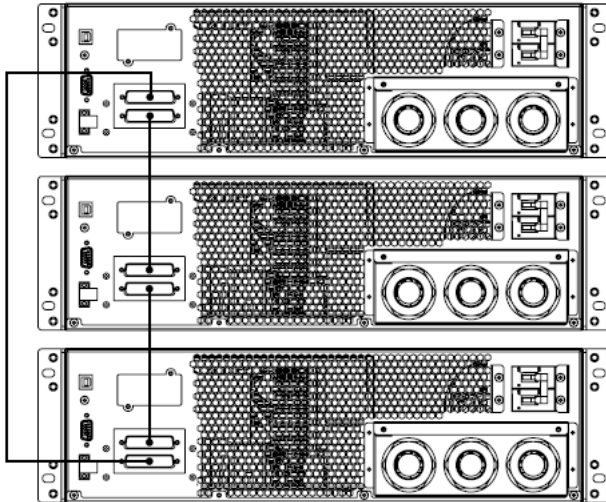

Fig.8-1 Parallel cable connect diagram

- 3) Strictly follow the chapter of 6.1, the wiring requirement of single UPS to perform the wiring of each UPS.

- 4) Connect the output wires of each UPS to an output breaker panel, and connect each output breaker to a main output breaker and then to the loads.
- 5) **Each UPS needs an independent battery pack.**
- 6) Please refer to the wiring diagram in the following diagram.

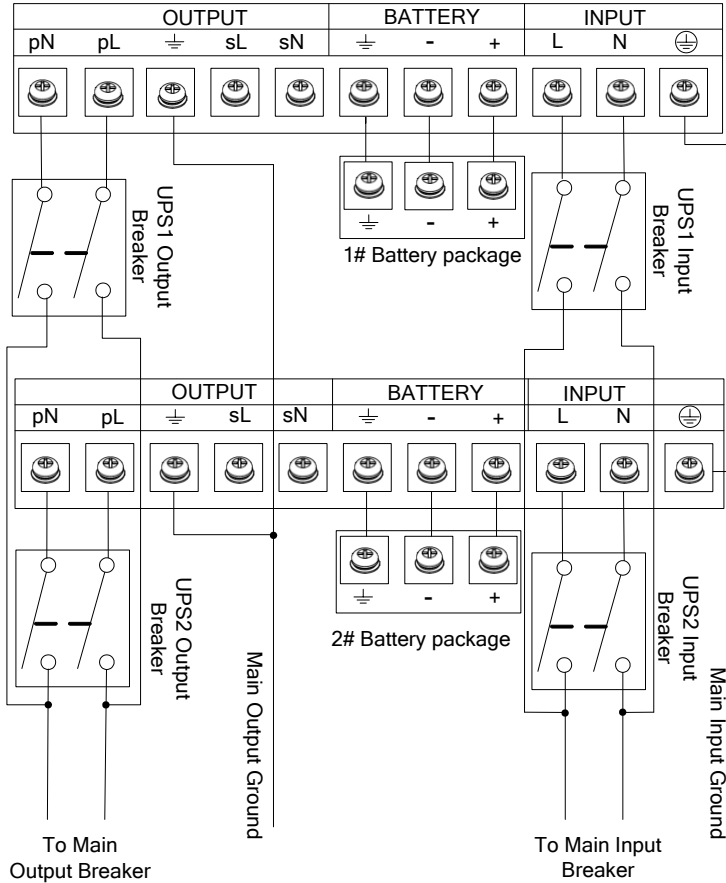

Fig.8-2 Input and output terminal block wiring diagram

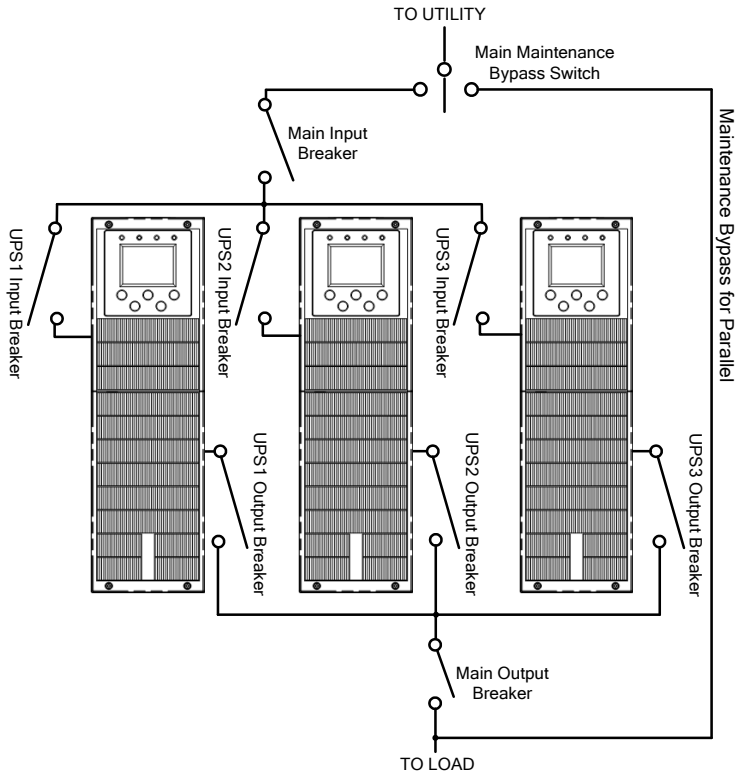







Fig.8-3 Parallel installation diagram

- 7) The distance between the UPS in parallel and the breaker panel is required to be less than 20 meters. The difference between the wires of input and output of the UPS is required to be less than 20%.
- 8) Do not switch on the output breaker of each UPS, switch on the input breaker of the each UPS, the UPS should work in bypass with output, observe their display to check if there are any warning or fault information, measure the output voltage of each UPS separately to check if the voltage difference between them is less than 1V. If the difference is more than 1V, check the wiring.
- 9) Press the button  of one UPS, each UPS would start to turn on, all the UPS would transfer to the Line mode together. Measure the output voltage of each UPS separately to check if the voltage difference between them is less

than 0.5V. If the difference is more than 0.5V, the UPS need to be regulated.

- 10) Press the button  of one UPS, each UPS would start to turn off and transfer to the Bypass mode, switch on the output breaker of each UPS to parallel all the output of UPS together.
- 11) Press the button  of one UPS, each UPS would start to turn on , after turning on, the UPS should work parallel in the Line mod

How to join a new UPS to a parallel system:

- 1) First the parallel system must be installed one main maintenance bypass switch.
- 2) Regulate the output voltage of the new UPS separately: check if the output voltage difference between the new UPS and the parallel system is less than 0.5V.
- 3) Ensure the bypass of the parallel system is normal and the bypass setting is "enable", Press the button  of one UPS, each UPS would turn off and the UPS system would transfer to the Bypass mode.
- 4) Set the main maintenance bypass switch from "UPS" to "BPS", switch off the main output breaker and the main input breaker, the UPS would shut down.
- 5) Ensure the UPS shut down totally, add the new UPS and reinstall the new UPS parallel system by following step 1) to 10) of last chapter - "How to install a new parallel UPS system".
- 6) Switch on the main input breaker and the main output breaker, and set the main maintenance bypass switch from "BPS" to "UPS", Press the button  of one UPS, each UPS would start to turn on, after turning on, the UPS should work parallel in the Line mode.

How to remove a single UPS from a parallel system:

- 1) First the parallel system must be installed one main maintenance bypass switch.
- 2) Ensure the bypass of the parallel system is normal and the bypass setting is "enable", Press the button  of one UPS, each UPS would turn off and the UPS system would transfer to the Bypass mode.
- 3) Set the main maintenance bypass switch from "UPS" to "BPS", switch off the main output breaker and the main input breaker, the UPS would shut down.
- 4) Ensure the UPS shut down totally, remove the wanted UPS and reinstall the new UPS parallel system by following step 1) to 10) of last chapter - "How to

install a new parallel system".

- 5) Switch on the main input breaker and the main output breaker, and set the main maintenance bypass switch from "BPS" to "UPS", Press the button  of one UPS, each UPS would start to turn on, after turning on, the UPS should work parallel in the Line mode.

9. Trouble Shooting

If the UPS system does not operate correctly, first check the operating information on the LCD display. Please attempt to solve the problem using the table below. If the problem still persists, consult your dealer.

9.1. Trouble Shooting According To Warning Indication

Problem Displayed	Possible cause	Remedy
EPO active	EPO connector is open	Check the EPO connector status
Site fail	The ground wire is disconnected, or phase and neutral conductor at input of UPS system are reversed.	Check the Ground wire status. Reverse mains power wiring.
Fan warning	Fan blocked or disconnected	Check the fan status
Battery open	Battery is disconnect	Do the battery test to confirm Check the battery bank is connected to the UPS. Check the battery breaker is turn on
Battery volt low	Battery voltage is low	When audible alarm sounding every second, battery is almost empty
Bat over voltage	Battery voltage is higher than normal value	Check if the battery quantity is right

Over charged	Battery is over charged	The UPS will turn off the charger until the battery voltage is normal
Over load	Over load	Check the loads and remove some non-critical loads. Check if some loads are failed
Charger fail	The charge fails	Consult dealer
Amb NTC abnormal	The ambient temperature is too high	Check the environment ventilation
Over temperature	Inside temperature of UPS is too high	Check the ventilation of UPS and the ambient temperature
Cable disconnect	The parallel cable is disconnected	Check the parallel cable
Cable loss	The parallel cable is disconnected	Check the parallel cable
Battery differ	The battery packs of some UPS are disconnected	Check if all the battery pack is connected
Line differ	The mains input of some UPS is disconnected	Check the building wiring and input cable. Check if the input breaker is closed. Ensure the UPS are connected to same input source
Work Mode differ	There are different power strategy setting in parallel system	The UPS with different power strategy setting (Ex. one Line mode and one Converter mode) are forbidden to parallel
Setting differ	There are different setting in parallel system	Check the setting
ECO In Parallel	ECO function is enabled in parallel system	ECO function is forbidden in parallel system
Fuse open	Input fuse break	Check the input fuse status

9.2. Trouble Shooting According To Fault Indication

Problem Displayed	Possible cause	Remedy
Output short	Output short circuit	Remove all the loads. Turn off the UPS. Check if UPS output and loads is short circuit. Ensure short circuit is removed before turning on again.
Over load	Over load	Check the loads and remove some non-critical loads. Check if some loads are failed.
Neg power fail	The load is pure inductive and capacitive	Remove some non-critical loads. Bypass supplies the load first, ensure there is no overload, then turn on UPS
Over temperature	Inside temperature of UPS is too high	Check the ventilation of UPS and the ambient temperature
Fan fail	Fan blocked or disconnected over time	Check the fan status
Back feed	Output voltage is returned to input	Consult dealer
DC short	Bus short	Consult dealer.
DC over	Bus over voltage	Consult dealer.
DC under	Bus under voltage	Consult dealer.
DC unbalance	Bus unbalance	Consult dealer.
DC soft fail	Bus soft start fail	Consult dealer.
Output soft fail	Output soft start fail	Consult dealer.
Output volt low	Output volt low	Consult dealer.
Output volt high	Output volt high	Consult dealer.

9.3. Trouble Shooting In Else Cases

Problem	Possible cause	Remedy
No indication, no warning tone even though system is connected to mains power supply	No input voltage	Check the building wiring and input cable. Check if the input breaker is closed
BYPASS LED light up even though the power supply is available	Inverter not switched on	Press button  to turn on UPS.
BATTERY LED lights up, and audible alarm sounding every 1 beep in every 4 seconds	Input voltage and/or frequency are out of tolerance	Check input power source. Check the building wiring and input cable. Check if the input breaker is closed.
Emergency supply period shorter than nominal value	Batteries not fully charged /batteries defect	Charge the batteries for at least 12 hours and then check capacity.

Please have the following information at hand before calling the After-Sales Service Department:

- 1) Model number, serial number
- 2) Date on which the problem occurred
- 3) LCD/LED display information, Buzzer alarm status
- 4) Mains power condition, load type and capacity, environment temperature, ventilation condition
- 5) The information (battery capacity, quantity) of external battery pack
- 6) Other information for complete description of the problem

10. Battery Maintenance

Battery replacement should be performed by qualified personnel.

- This series UPS only requires minimal maintenance. The batteries used for battery pack are value regulated sealed lead-acid maintenance free battery. These models require minimal repairs. The only requirement is to charge the UPS regularly in order to maximize the expected life of the battery. When being connected to the utility power, whether the UPS is turned on or not, the UPS keeps charging the batteries and also offers the protective function of overcharging and over-discharging.

- The UPS should be charged once every 4 to 6 months if it has not been used for a long time.
- In the regions of hot climates, the battery should be charged and discharged every 2 months. The standard charging time should be at least 12 hours.
- Under normal conditions, the battery life lasts 3 to 5 years. In case if the battery is found not in good condition, earlier replacement should be made. Battery replacement should be performed by qualified personnel.
- Replace batteries with the same number and same type of batteries.
- Do not replace the battery individually. All the batteries should be replaced at the same time following the instructions of the battery supplier.
- If the battery service life (3~5 years at 25°C ambient temperature) has been exceeded, the batteries must be replaced.

11. Communication Port

11.1. USB Interface

The USB port is compliance with USB 1.1 protocol for its communication software.

11.2. RS 232 Interface

The RS-232 port is available for UPS monitoring, control, and firmware updates.

11.3. Intelligent slot

This series is equipped with an intelligent slot for other optional card to achieve remote management of the UPS through internet / intranet. Please contact your local distributor for further information.

CyberPower Systems Inc.

www.cyberpower.com

6F, No. 32, Sec. 1, Chenggong Rd., Nangang District, Taipei 115, Taiwan

Entire contents copyright© 2013 CyberPower Systems Inc., All rights reserved. Reproduction in whole or in part without permission is prohibited. PowerPanel® Business Edition and PowerPanel® Personal Edition are trademarks of CyberPower Systems Inc.

